

TG SERIES TYPE L

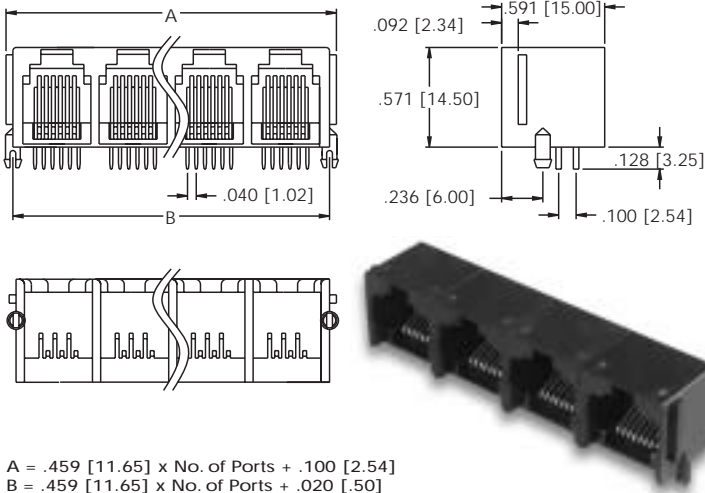

TG SERIES TYPE M

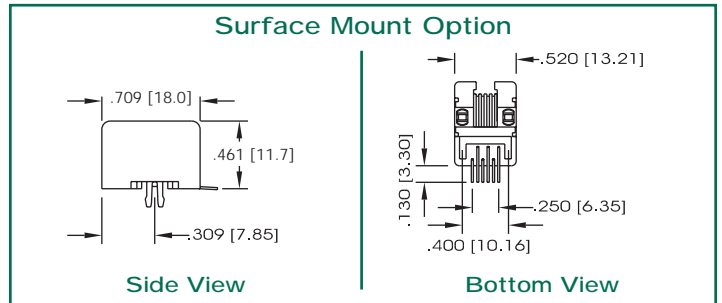
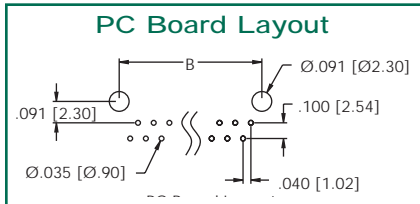
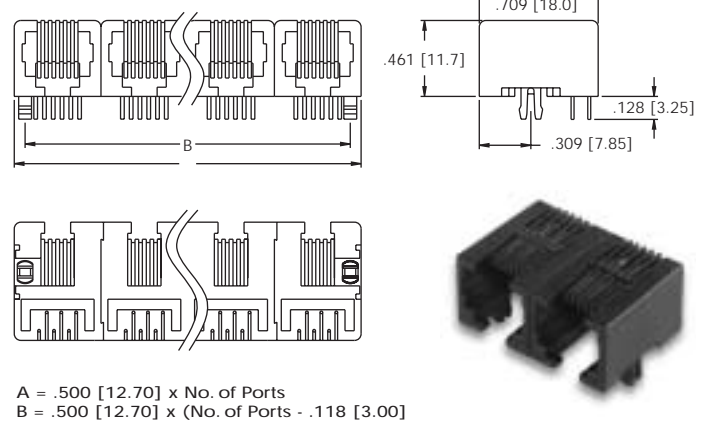

TG SERIES TYPE N

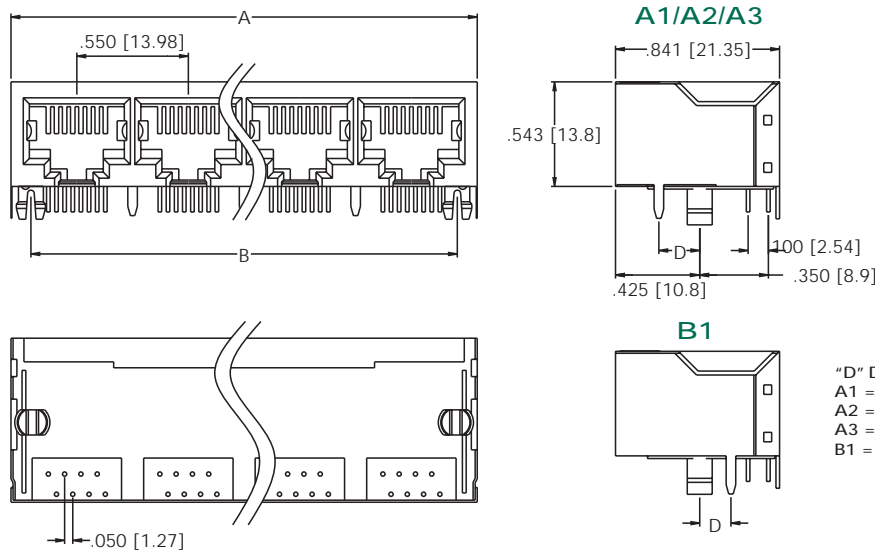

Unit: inch/mm

No. of Ports	Dimension		
	4	6	8
A	2.33	3.43	4.53
	59.12	87.06	115.00
B	2.10	3.20	4.30
	53.34	81.28	109.22
C	2.31	3.41	4.51
	58.67	86.61	114.55

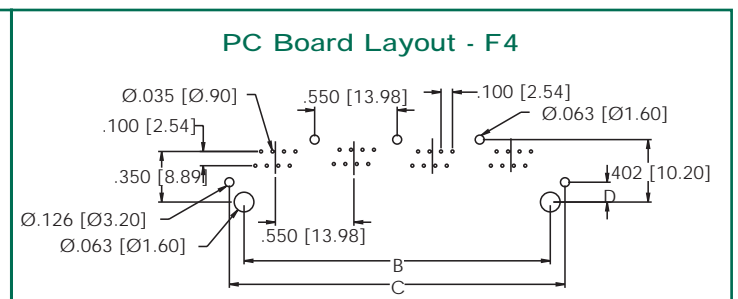
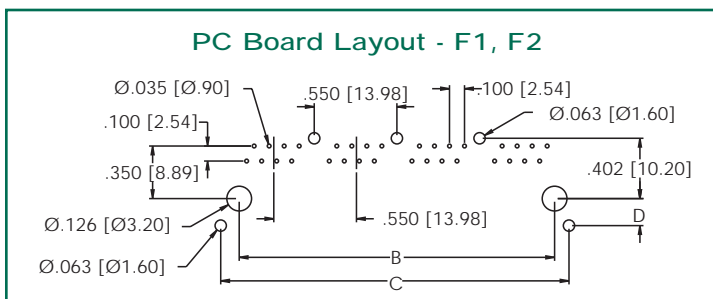

TELEPHONE JACK

GANG JACK UL / CSA / FCC APPROVED



TG SERIES TYPE P / STACKED TELEPHONE JACK

Dimensional:			
Part Number	Ports	A	C
TG6-P-8P8C-1-FS	2 x 3	1.78 (45.21)	1.55 (39.37)
TG8-P-8P8C-1-FS	2 x 4	2.33 (59.18)	2.10 (53.34)
TG12-P-8P8C-1-FS	2 x 6	3.43 (87.10)	3.20 (81.28)

Unit: inch/mm

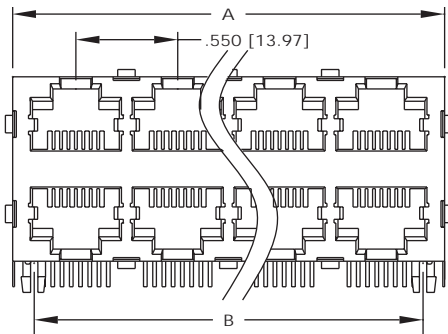
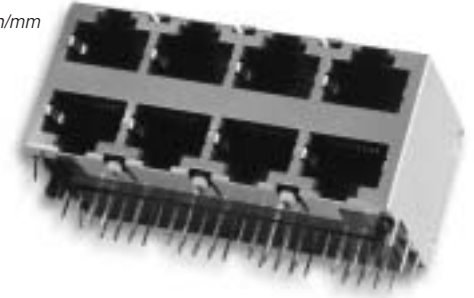
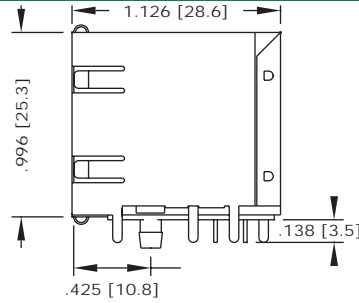
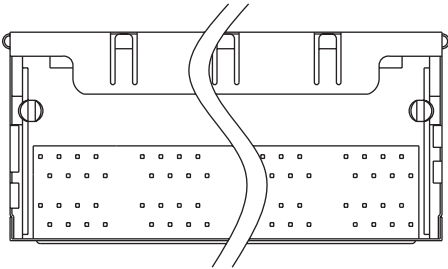

PC Board Layout

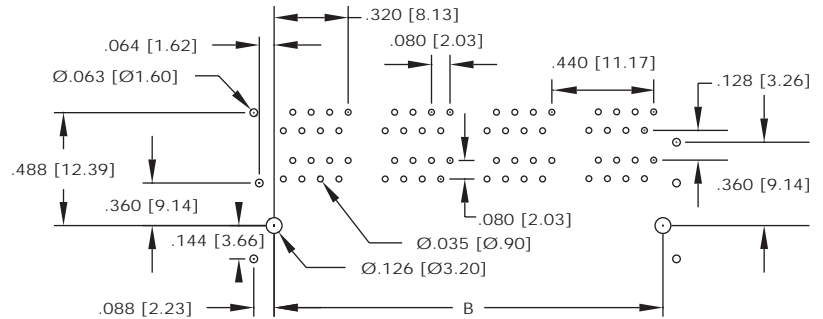

TG SERIES TYPE Q / FLAT GANGED TELEPHONE JACK

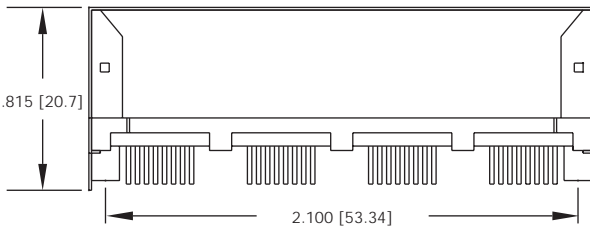
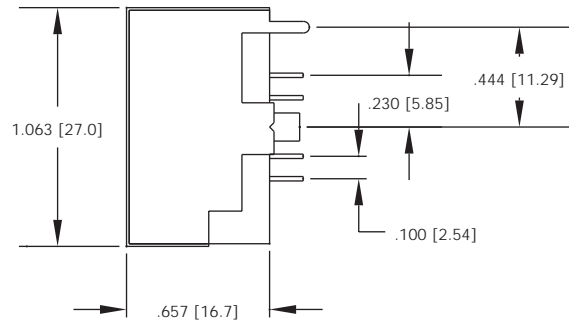
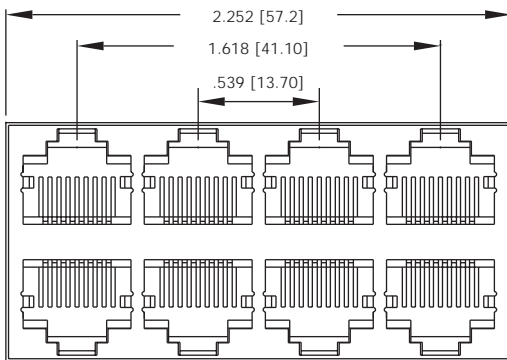

PC Board Layout

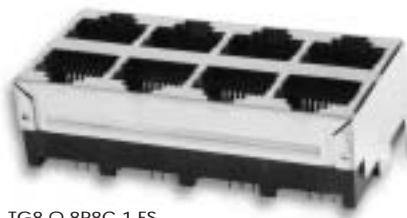
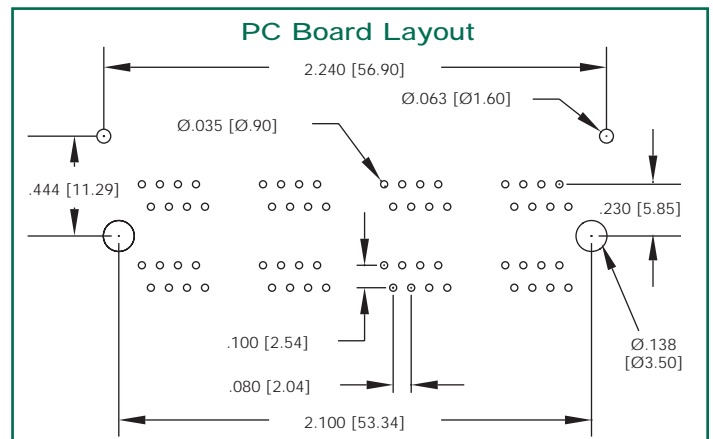

TG8-Q-8P8C-1-FS