

TELEPHONE JACK

MODULAR TELEPHONE JACK UL/CSA/FCC APPROVED



SPECIFICATIONS

Material:

Insulator: PBT glass-reinforced thermoplastic, rated UL 94V-0, ABS or Hi-Temp nylon 6T.

Contacts: Phosphor Bronze

Shield: Phosphor Bronze, bright tin-plated

Plating:

50 µin gold (optional 30 or 15 µin) on contact area over 50 µin nickel underplate. Gold or tin on solder tails.

Electrical:

Operation voltage: 250 VAC max

Current rating: 2 Amps max

Contact resistance: 20 mΩ max

Insulation resistance: 500 MΩ min @ 1000 VDC between adjacent contacts (75°F and 50% R.H.)

Dielectric withstanding voltage: 1000 VAC min rms (sea level)

Capacitance: 1.5 pF max between adjacent contacts



ORDERING INFORMATION

choose one from each category as shown in sample below

T	A	8P8C	3	
Series	Type	Position / Contacts	Plating	Options (add as suffix to part number)
T - Telephone Jack Single Port Pg. 24-27	A - V	4P4C, 6P4C, 6P6C, 8P8C, 10P10C	1 - 15 mi Gold on Contact Area 2 - 30 mi Gold on Contact Area 3 - 50 mi Gold on Contact Area	C - Gray Color Insulator S - Front Shield F - Full Shield NP - No Panel Stops K - Keyed (8P8C Only) SMT - SMT Leads PG - Panel Ground A1-A6 & B1-B5 See Pg. 30 for Shielding Options
TG - Telephone Jack Ganged 2 thru 12 Ports. Designate as TG2 thru TG12 Pg. 28-29	Magnetic Jacks: SX, TX, UX, VX			
TU - Telephone Jack with Dual Port USB	X: 1- 1:1 / 1:1 2- 1:414:1 / 1:1 3- 2:1 / 1:1			

TYPE A 6P4C / 6P6C

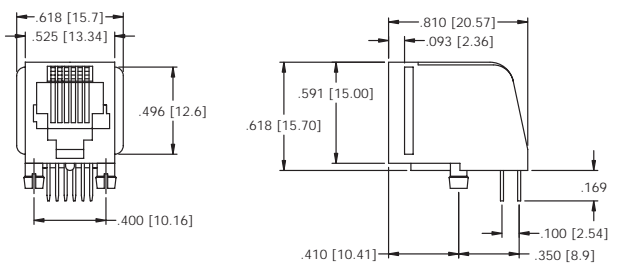

TYPE A 8P8C

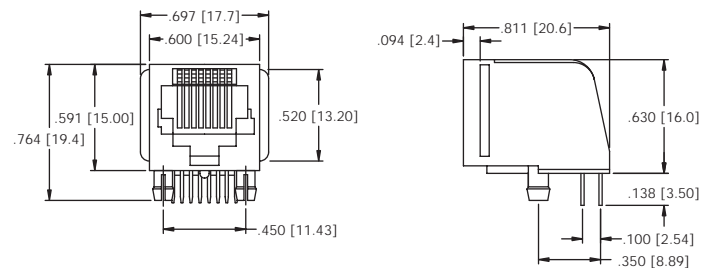

TELEPHONE JACK

MODULAR TELEPHONE JACK UL/CSA/FCC APPROVED



TYPE B 4P4C / 6P6C

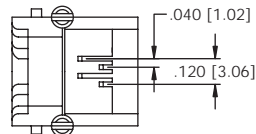
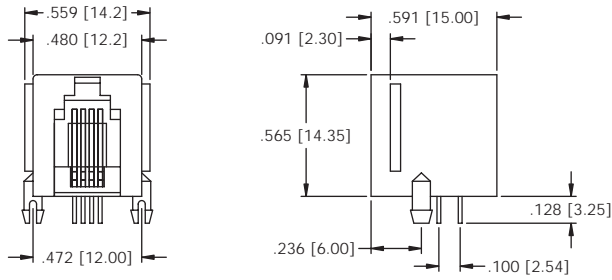

TYPE B 6P4C / 6P6C

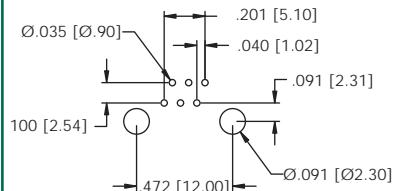
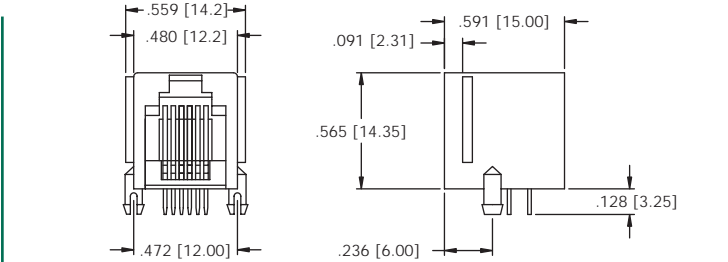

PC Board Layout

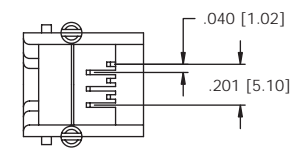

TYPE C 6P4C / 6P6C

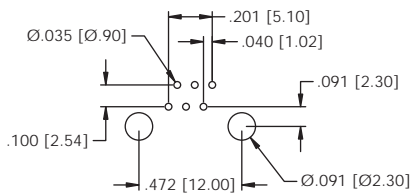
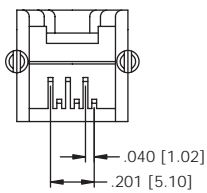
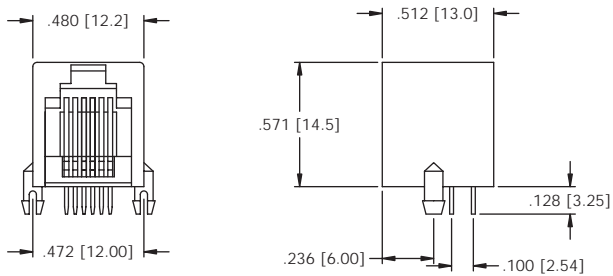

PC Board Layout

TYPE C 8P8C

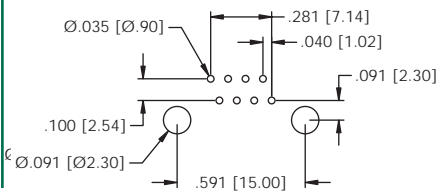
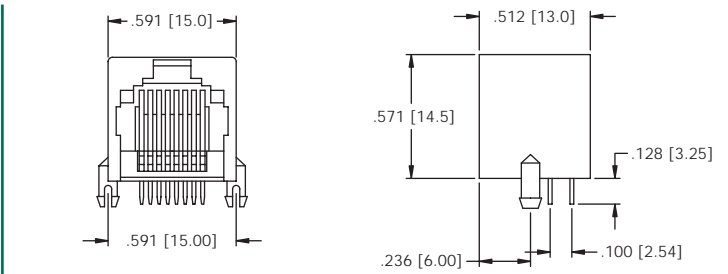

PC Board Layout



TYPE D 6P4C / 6P6C

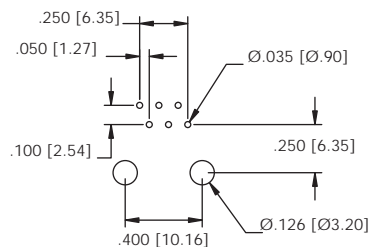
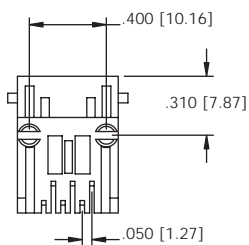
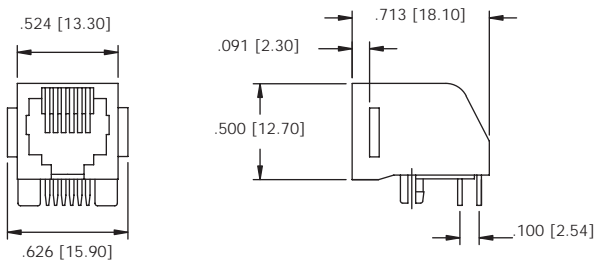

PC Board Layout

TYPE D 8P8C

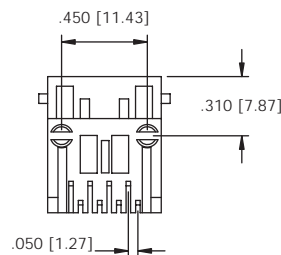
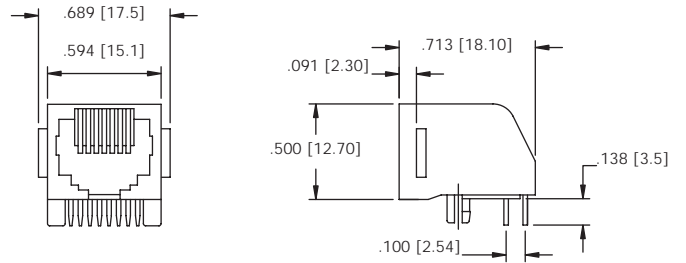

TELEPHONE JACK

MODULAR TELEPHONE JACK UL/CSA/FCC APPROVED



TYPE E 6P4C

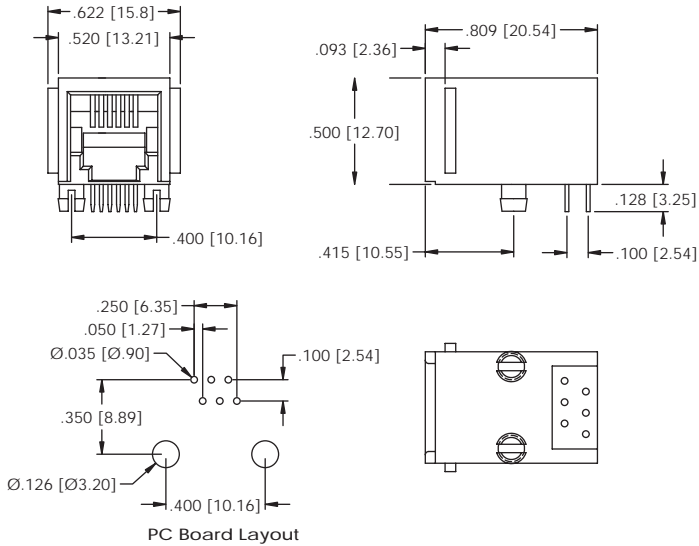

TYPE E 8P8C

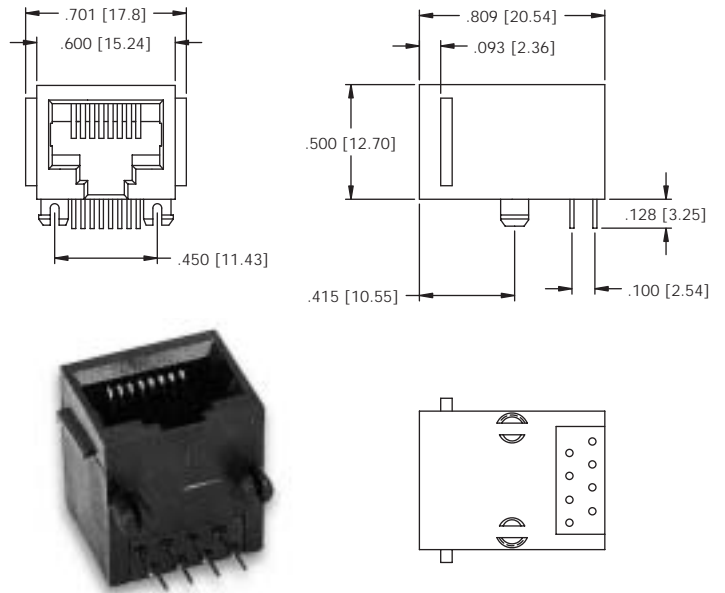

TYPE E 6P4C / 6P6C SHIELDED

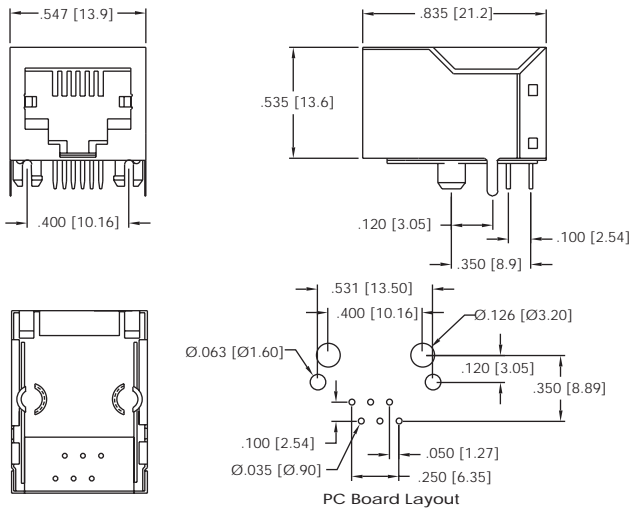

TYPE E 8P8C SHIELDED

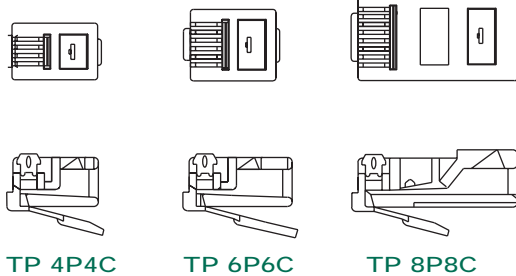
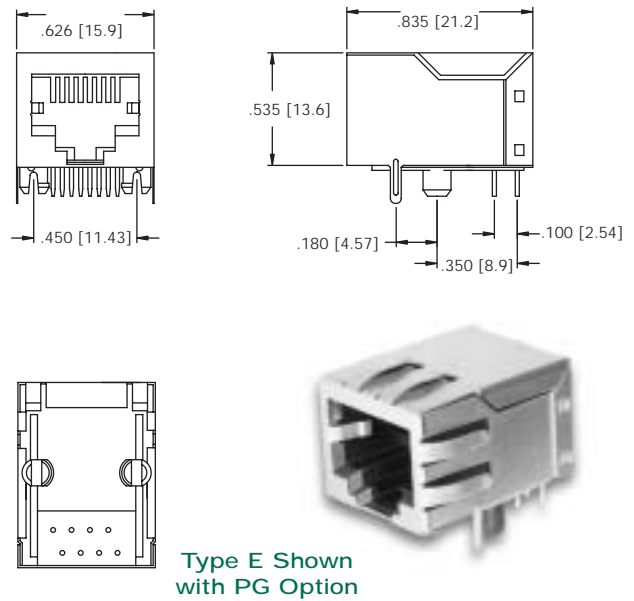

ORDERING INFORMATION

choose one from each category as shown in sample below

TP	8P8C	G	F	0
Series	Positions/Contacts	Plating	Cable Type	Options
TP - Telephone Plug	4P2C, 4P4C, 6P6C, 8P8C, 10P10C	1 - 15 µin Gold 2 - 30 µin Gold 3 - 50 µin Gold	F - Flat Cable R - Round Cable	0 - No Shield S - Solid Wire K - Keyed EMI - Shielded

TELEPHONE JACK

MODULAR TELEPHONE JACK UL/CSA/FCC APPROVED



TYPE F 6P4C / 6P6C

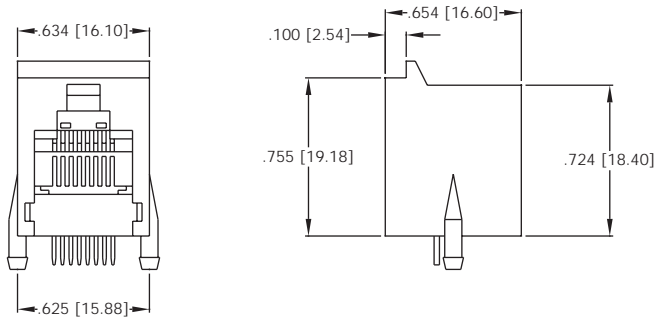

6P4C
6P6C

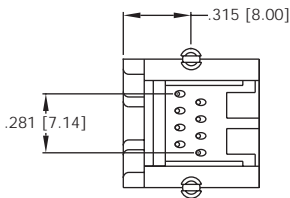

TYPE F 8P8C

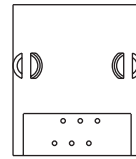
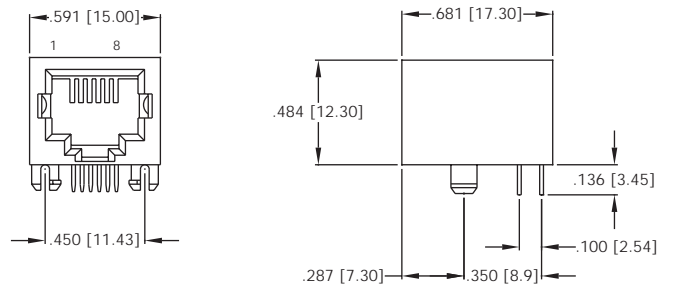

8P8C

TYPE G 6P4C / 6P6C

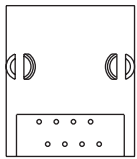
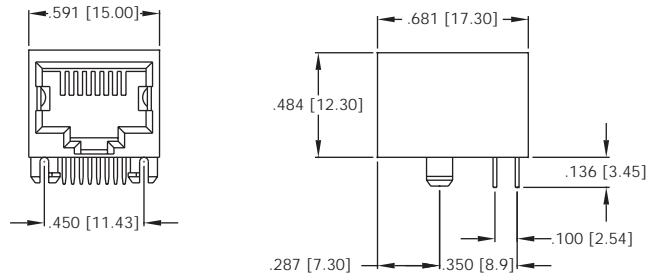

6P4C
6P6C

TYPE G 8P8C

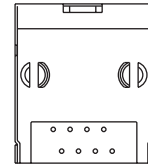
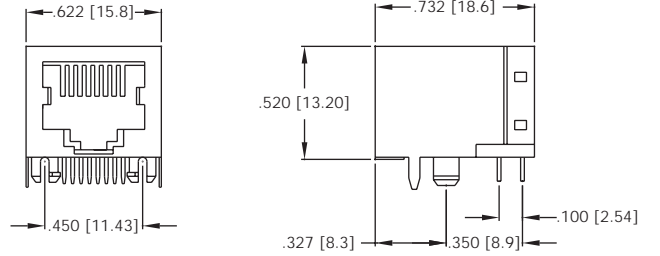

8P8C

TYPE H 4P4C

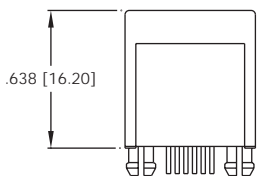
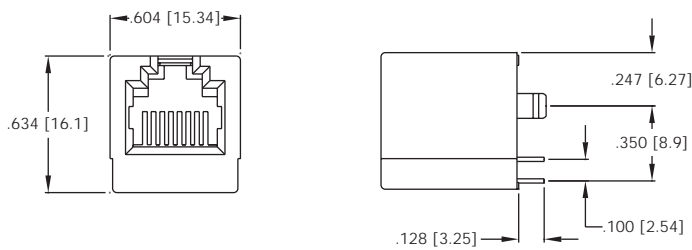

4P4C

TYPE H 6P4C / 6P6C

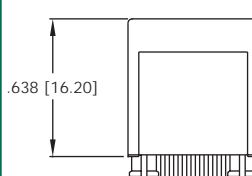
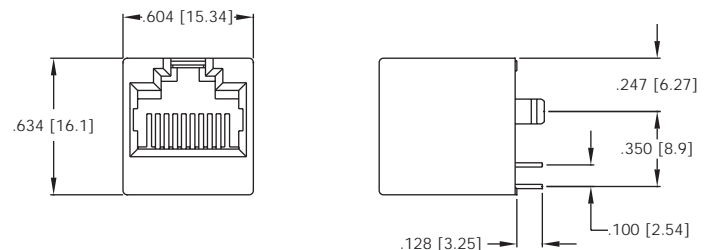

6P4C
6P6C

TELEPHONE JACK

MODULAR TELEPHONE JACK UL/CSA/FCC APPROVED



TYPE I 8P8C

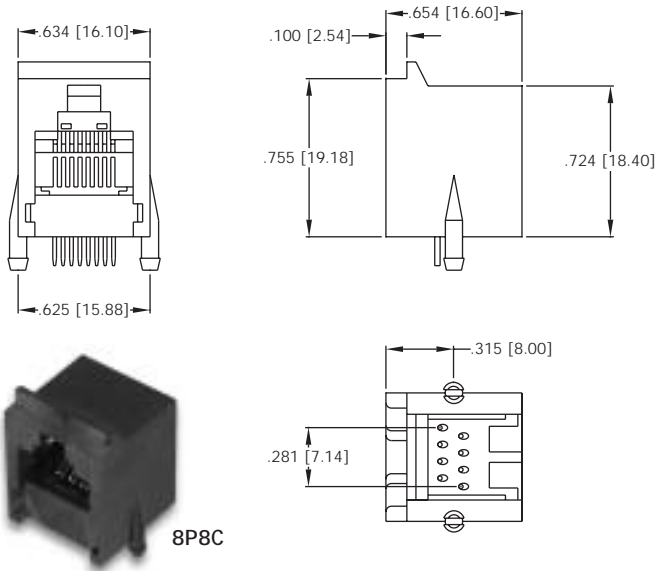

TYPE J 6P4C / 6P6C

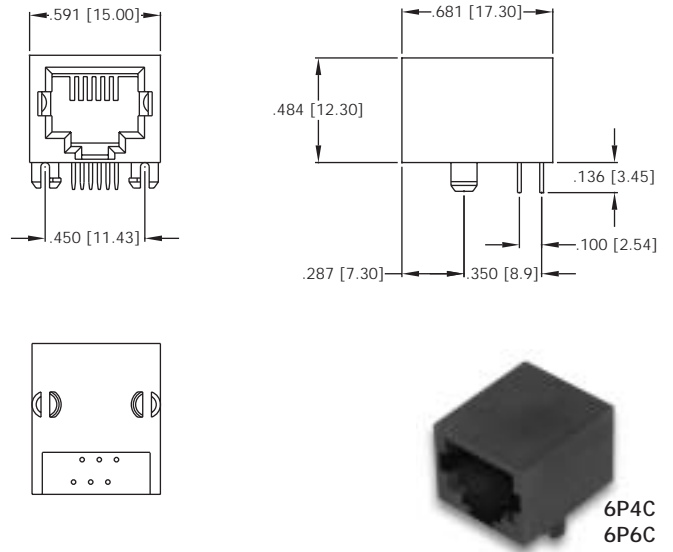

TYPE J 8P8C

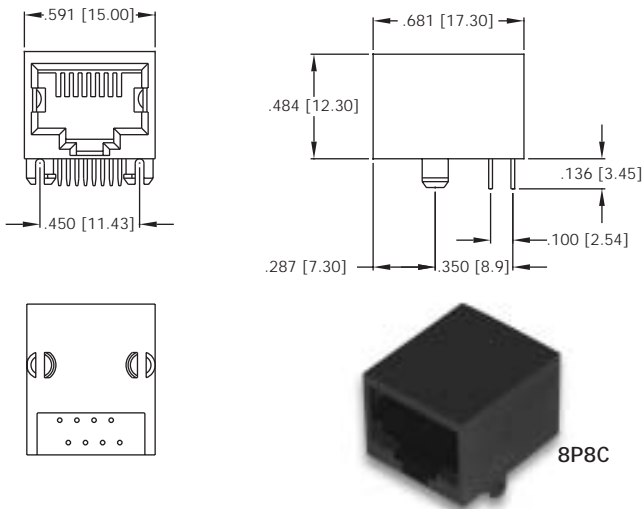

TYPE J WITH "F" SHIELDING OPTION

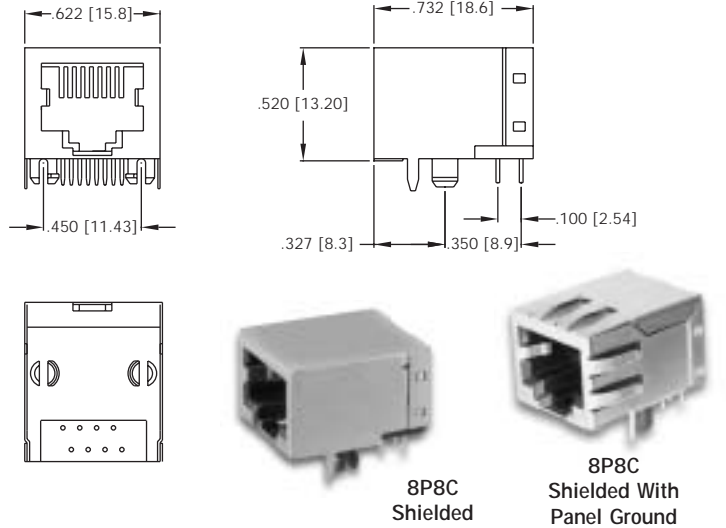

TYPE K 6P4C / 6P6C

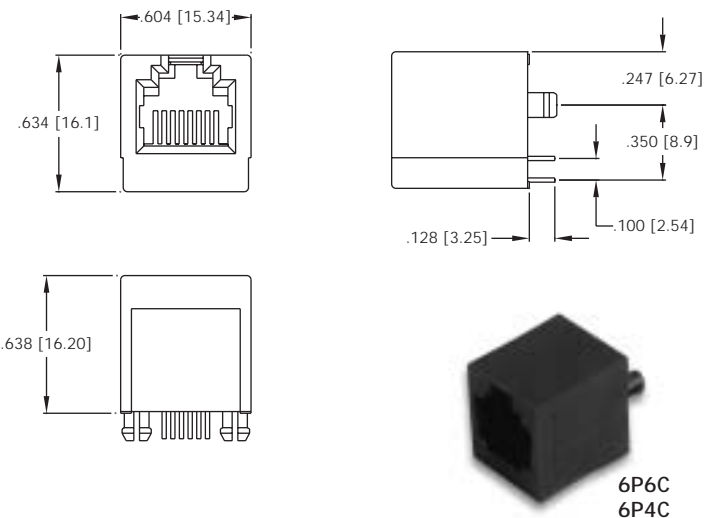

TYPE K 8P8C

